



ASSEMBLY INSTRUCTIONS

PENNY

ITEM CODE **63364**

Imported by Amart Furniture Pty Ltd, Qld, Brisbane Australia.
For any assistance with assembly or for missing parts please phone
Amart Ewing Road, Customer Service Free call 1800 351 084

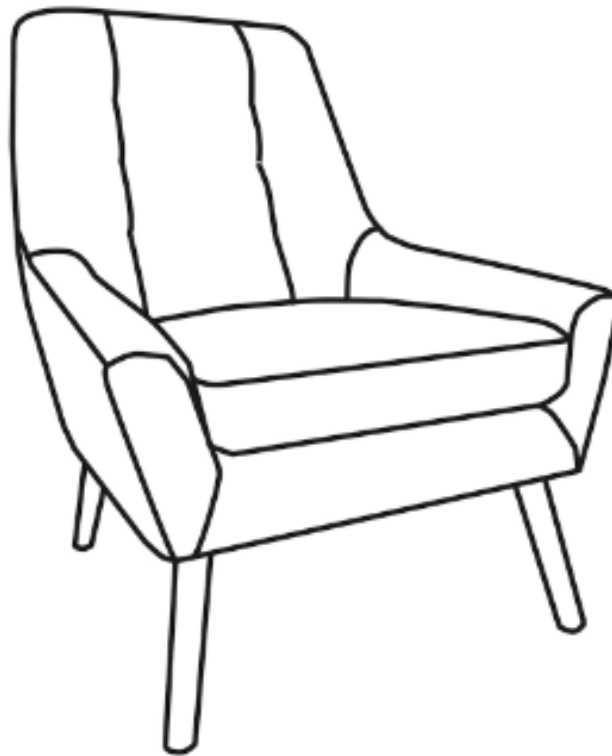

Imported by Amart Furniture Pty Ltd, Qld, Brisbane Australia.
For any assistance with assembly or for missing parts please phone
Amart Ewing Road, Customer Service Free call 1800 351 084

PRE-ASSEMBLY PREPARATION

Before you start:

1. Choose a clean, level, spacious assembly area. Avoid hard surfaces that may damage the product
2. Take care when lifting. Product should be assembled as near as possible to the point of use
3. Ensure that you have all required contents for complete assembly
4. Always read the assembly instructions carefully before beginning assembly.
5. Keep all hardware parts and packaging out of reach of small children.
6. Do not over tighten the screws and bolts as this may damage the threads



5

ALLOW MINUTES







1

PEOPLE REQUIRED

63364

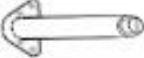
PARTS LIST

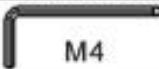
Hardware List			
A		Chair	1PC
B		Seat Cushion	1PC
C		TWO LONGER FRONT LEGS MARK "F"	2 PCS
D		TWO SHORTER BACK LEGS MARK "R"	2 PCS
E	 Φ6mm*h13mm	Bolts	16PCS
F	 M4	Allen Key	1PC

STEP 1: Turn over onto blanket or carpet to ensure no damage to item

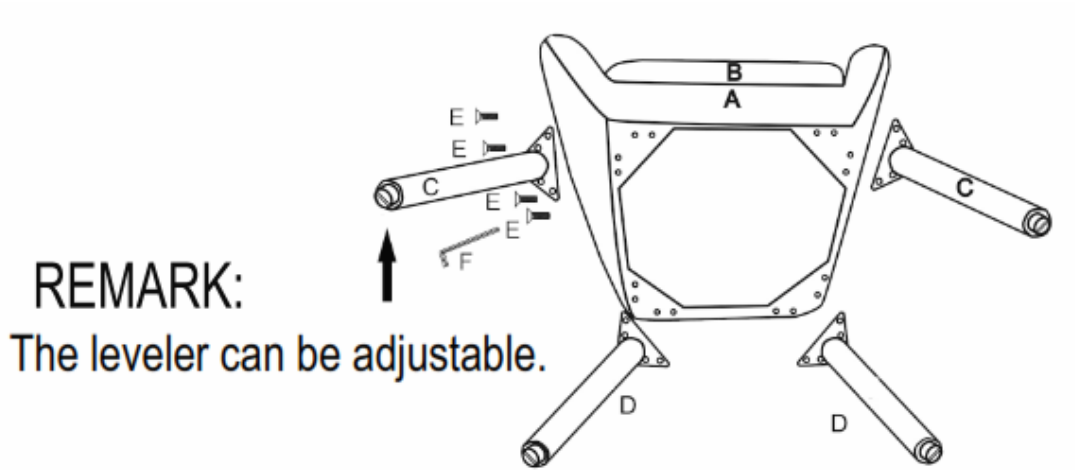

ASSEMBLY IS COMPLETE

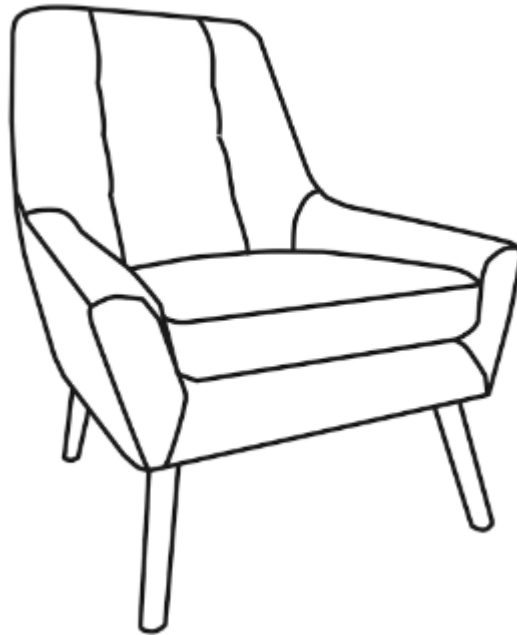

CARE AND MAINTENANCE

PRODUCT CARE:

Protect from direct sunlight, direct heat and weather.

All covers will fade over time.

Do not remove covers for cleaning.

Vacuum regularly using low suction.

Professional cleaning recommended.

Blot food and liquid spills immediately with a dry, white, clean cloth. Do not rub.

If required for further cleaning, use a mild non-coloured pure soap solution made from soap flakes mixed with warm water.

Dry in shade away from direct heat and sunlight.

Allow to dry thoroughly.

CHAIRS AND STOOLS

•Do not:

- Use chair/stool as a ladder
- Climb on the chair/stool
- Stand on the foot-rest of the chair, as this could lead to the stool becoming unbalanced and overturning